



JF QUICK LIST
**SPARE
PARTS**

Ren og skær fornuft - JF originale dele -

Velkommen til JF-Fabrikens sliddelskatalog!

Med dette sliddelskatalog har vi bestræbt os på at stille et værktøj til rådighed, som kan give dig et hurtigt overblik over de sliddele, du har brug for i det daglige arbejde med dine JF maskiner.

Mere end 50 års erfaring i at designe og producere slid- og reservedele til krævende kunder er din garanti for at få JF slid- og reservedele af høj kvalitet.

Det er - ren og skær fornuft - at vælge JF originale slid- og reservedele, og det er samtidig din garanti for den bedste totaløkonomi fordi:

- Originale dele er konstrueret til lang levetid.
- Sliddelene er specielt konstrueret til vore maskiner og sikrer dermed det bedste arbejdsresultat.
- De høje kvalitetskrav til JF slid- og reservedele sikres med den bedste produktionsteknik og omfattende kontinuerlig afprøvning.
- Den høje kvalitet og det gode design af sliddelene sikrer, at JF maskinerne præsterer det maksimale.
- JF originale dele sikrer en let montering på vores maskiner.
- Din forhandler har altid de mest anvendte slid- og reservedele til dine maskiner.

Vi kan ikke forhindre, at din JF maskine skal have udskiftet slid- eller reservedele, men vi har gjort det til en af vores kernekompetencer at sikre en høj servicegrad på JF eftermarkedet, således at den tid, din maskine står stille, bliver absolut minimal.

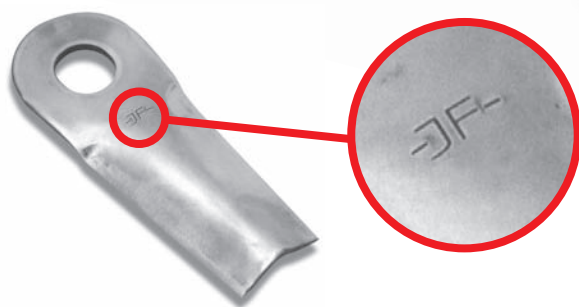

***JF originale dele
- sikrer det
optimale!***

Indhold - Contents - Inhalt

4 - 9 **Skiveslåmaskiner**
Disc Mowers
Scheibenmäher



10 - 14 **Rotorslåmaskiner**
Drum Mowers
Trommelmäher



15 **River**
Rakes
Kreiselwender



16 - 18 **Vogne**
Wagons
Wagen



19 - 23 **Snittere**
Forage Harvesters
Exakthäcksler









24 - 26 **Fuldfodervogne**
Complete Diet Mixers
Futtermischwagen









27 - 30 **Diverse**
Miscellaneous
Diverse









Skiveslåmaskine - Disc Mower - Scheibenmäher

Product	-JF- Part no.	Type of machine
	1362-9803 Remsæt V-Belt set Riemensatz	GMS TS
	1362-9804 Remsæt V-Belt set Riemensatz	GMS TS
	3229-781x 25 stk. 2226-070x+ 2226-071x 25 pcs. 2226-070x+ 2226-071x 25 Stck. 2226-070x+2226-071x	GMS TS
	1380-0013 Kniv Knife Messer	GMS TS
	3081-601x Knivbolte Knifebolts Messerbolzen	GMS TS
	2228-560x Modskær Shearbar Gegenschneide	GMS TS
	3081-036x Stenbeskytter Stone protection Steinschutz	GMS TS

Skiveslåmaskine - Disc Mower - Scheibenmäher

Product	-JF- Part no.	Type of machine
	3226-805b Slæbesko Guide shoe Gleitkufe	GMS 2400/3200/3600 TS GMS 2400/3200/3600 Flex
	3228-608x Skive Disc Tellerscheibe	GMS TS
	2085-642x Lejeenhed Bearing housing Lagergehäuse	GMS TS
	3228-794b Slæbesko Guide shoe Gleitkufe	GMS 2800 TS GMS 2800 Flex
	2229-499x Modskær Shearbar Gegenschneide	GMS 2800 TS
	1362-9705 Remsæt V-belt set Riemensatz	GMS FLEX
	1362-9805 Remsæt V-belt set Riemensatz	GMS FLEX

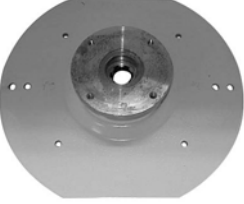





Skiveslåmaskine - Disc Mower - Scheibenmäher

Product	-JF- Part no.	Type of machine
	3081-036x Stenbeskytter Stone protection Steinschutz	GMS FLEX
	2228-560x Modskær Shearbar Gegenschneide	GMS FLEX
	3081-601x Knivbolte Knife bolts Messerbolzen	GMS FLEX
	3228-794b Slæbesko Guide shoe Gleitkufe	GMS 2800 FLEX
	3086-643x Indgangsskive Inner disc Eingangsscheibe	GMS 2800/3600 TS GMS 2800/3600 FLEX
	3228-753x Yderskive Outer disc Aussenscheibe	GMS 2800/3200/3600 TS GMS 2800/3200/3600 FLEX
	3228-744x Indgangsskive Input disc Eingangsscheibe	GMS 3200 TS GMS 3200 Flex





Skiveslåmaskine - Disc Mower - Scheibenmäher

Product	-JF- Part no.	Type of machine
	3228-608x Skive Disc Tellerscheibe	GMS 2800 FLEX
	2085-642x Lejeenhed Bearing housing Lagergehäuse	GMS 2800 FLEX
	3226-805b Slæbesko Guide shoe Gleitkufe	GMS 3200/3600 FLEX
	1362-9804 Remsæt V-belt set Riemensatz	GMS 3600 FLEX
	1362-9803 Remsæt V-belt set Riemensatz	GMS 3202 collector
	1362-9805 Remsæt V-belt set Riemensatz	GMS 3202 collector
	3229-781x 25 stk. 2226-070x+ 2226-071x 25 pcs. 2226-070x+ 2226-071x 25 Stck. 2226-070x+2226-071x	GMS 3202 collector







Skiveslåmaskine - Disc Mower - Scheibenmäher

Product	-JF- Part no.	Type of machine
	<p>2085-642x</p> <hr/> <p>Lejeenhed Bearing housing Lagergehäuse</p>	<p>GMS 3202 collector</p>
	<p>1380-0013</p> <hr/> <p>Kniv Knife Messer</p>	<p>GMS 3202 collector</p>
	<p>3228-608x</p> <hr/> <p>Skive Disc Tellerscheibe</p>	<p>GMS 3202 collector</p>
	<p>3081-601x</p> <hr/> <p>Knivbolte/ møtrikker Knifebolts/ nuts Messerbolzen/ Mutter</p>	<p>GMS 3202 collector</p>
	<p>3226-805b</p> <hr/> <p>Slæbesko Guide shoe Gleitkufe</p>	<p>GMS 3202 collector</p>
	<p>3081-036x</p> <hr/> <p>Stenbeskytter Stone protection Steinschutz</p>	<p>GMS 3202 collector</p>
	<p>2228-560x</p> <hr/> <p>Modskær Shearbar Gegenschneide</p>	<p>GMS 3202 collector</p>





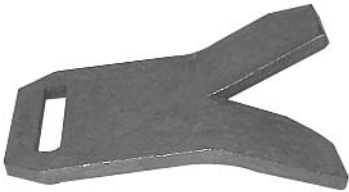

Skiveslåmaskine - Disc Mower - Scheibenmäher

Product	-JF- Part no.	Type of machine
	<p>3225-395x</p> <hr/> <p>Hat Cap Zylinder</p>	<p>GMS 3202 collector</p>
	<p>3228-753x</p> <hr/> <p>Yderskive Outer disc Ausenscheibe</p>	<p>GMS 3202 collector</p>
	<p>3228-744x</p> <hr/> <p>Indgangsskive Input disc Eingangsscheibe</p>	<p>GMS 3202 collector</p>
	<p>2228-652x</p> <hr/> <p>Indsats Insert Einsatz</p>	<p>GMS 3202 collector</p>

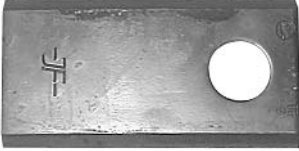

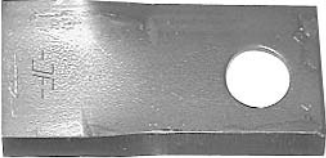
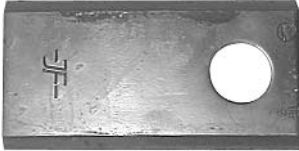

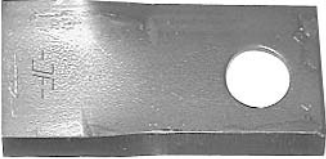

Rotorsl maskine - Drum Mower - Trommelm her

Product	-JF- Part no.	Type of machine
	2221-300a Medbringer Carrier Mitnehmer	CMT 245
	1380-0001 Kniv Knife Messer	CMT 245
	3221-378x Knivholder Knife support Messerhalter	CMT 245
	1380-0021/1380-0022 Kniv H + V Knife R + L Messer R + L	CMT 245
	2220-808x Finger Finger Finger	CMT 245
	1362-2407 Rems�t V-belt set Keilriemensatz	CMT 245
	1361-8511 Kilerem V-belt Keilriemen	CMT 245



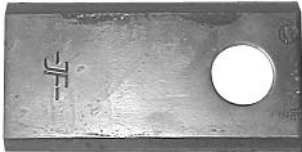
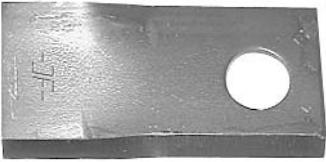



Rotorslåmaskine - Drum Mower - Trommelmäher

Product	-JF- Part no.	Type of machine
	1380-0025 Kniv Knife Messer	CM 170
	3224-023x Knivholder Knife support Messerhalter	CM 170
	1380-0023/1380-0024 Kniv H + V Knife R + L Messer R + L	CM 170
	1380-0025 Kniv Knife Messer	CM 190
	3223-445a Knivholder Knife support Messerhalter	CM 190
	1380-0023/1380-0024 Kniv H + V Knife R + L Messer R + L	CM 190
	3278-160x Knivholder Knife support Messerhalter	CM 3050 F



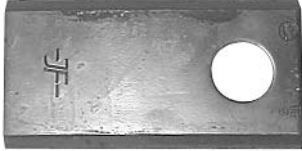

Rotorsl maskine - Drum Mower - Trommelm her

Product	-JF- Part no.	Type of machine
	<p>1380-0015/1380-0014</p> <p>Kniv H + V Knife R + L Messer R + L</p>	<p>CM 3050 F</p>
	<p>3224-023x</p> <p>Knivholder Knife support Messerhalter</p>	<p>CM 3050 F</p>
	<p>1380-0025</p> <p>Kniv Knife Messer</p>	<p>CM 2250 F</p>
	<p>1380-0023/1380-0024</p> <p>Kniv H + V Knife R + L Messer R + L</p>	<p>CM 2250 F</p>
	<p>1380-0014/1380-0015</p> <p>Kniv H + V Knife R + L Messer R + L</p>	<p>CM 265 F</p>
	<p>3279-527a</p> <p>Knivholder Knife support Messerhalter</p>	<p>CM 265 F</p>
	<p>1380-0027</p> <p>Kniv Knife Messer</p>	<p>CM 265 F</p>



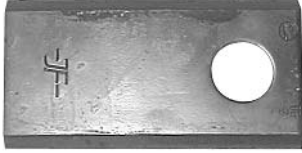

Rotorsl maskine - Drum Mower - Trommelm her

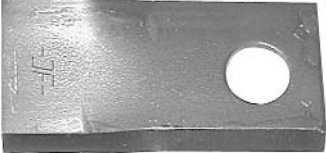
Product	-JF- Part no.	Type of machine
	3279-527a Knivholder Knife support Messerhalter	CM 2650 F
	1380-0027 Kniv Knife Messer	CM 2650 F
	1380-0014/1380-0015 Kniv H + V Knife R + L Messer R + L	CM 2650 F
	2279-590x Sl�besko Guide shoe Gleitkufe	CM 2650 F
	1380-0025 Kniv Knife Messer	CM 2250
	3224-023x Knivholder Knife support Messerhalter	CM 2250
	1380-0023/1380-0024 Kniv H + V Knife R + L Messer R + L	CM 2250



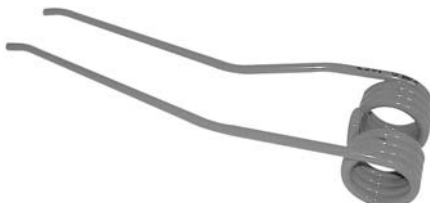

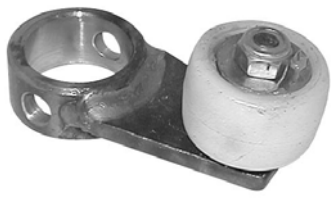

Rotorsl maskine - Drum Mower - Trommelm her

Product	-JF- Part no.	Type of machine
	3279-527a Knivholder Knife support Messerhalter	CM 2650
	2279-590x Sl�besko Guide shoe Gleitkufe	CM 2650
	1380-0014/1380-0015 Kniv H + V Knife R + L Messer R + L	CM 2650
	1380-0025 Kniv Knife Messer	CMT 2800
	3229-781x 25 stk. 2226-070x+ 2226-071x 25 pcs. 2226-070x+ 2226-071x 25 Stck. 2226-070x+2226-071x	CMT 2800
	3223-445A Knivholder Knife support Messerhalter	CMT 2800
	1380-0023/1380-0024 Kniv H + V Knife R + L Messer R + L	CMT 2800







River - Rakes - Kreiselwender

Product	-JF- Part no.	Type of machine
	1361-9608 Kilerem V-belt Keilriemen	CR 320
	3195-600x 3/ 1433-0200 + 2/1433-0201 3/ 1433-0200 + 2/1433-0201 3/ 1433-0200 + 2/1433-0201	CR 320 CR 400
	3195-033/3195-038x Rotorarm H + V Rotor arm R + L Rotorarm R + L	CR 320
	2501-080x Rivefjedre, yderste Tines, outer Federzinken, ausen	CRS 400
	2501-190x Rivefjedre, inderste Tines, inner Federzinken, innerer	CRS 400
	2501-330x Bøsning Bush Buchse	CRS 400
	3501-370x Styrerulle samlet Steering roller compl. Steuerungsrolle komp.	CRS 400







AV universalvogn - Universal Trailer - Allzweckwagen

Product	-JF- Part no.	Type of machine
	1364-3301 Kædeled Chain link Kettenglied	AV
	3133-009x Transportlamel Conveyor Slat Förderlamelle	AV
	3133-068X Kædehjul Chain wheel Kettenrad	AV
	2234-379x Medbringer Carrier Mitnehmer	Combi aflæsser Combined unloader Kombilader
	2112-492x/2112-493x HD Spredeblad H + V R.Beater lug R + L Streuschaufel R + L	AV
	2112-875x/2112-876x Spredeblad H + V R.Beater lug R + L Streuschaufel R + L	AV
	2231-099x/2231-100x Spredeblad H + V R.Beater lug R + L Streuschaufel R + L	AV







ST Super Transporter

Product	-JF- Part no.	Type of machine
	1364-3301 Kædeled Chain link Kettenglied	ST 70/90 ST 9500 ST 12000
	3111-143x Transportlamel Conveyor slat Förderlamelle	ST 70/90 ST 9500 ST 12000
	3133-068x Kædehjul Chain link Kettenglied	ST 70/90 ST 9500 ST 12000
	2112-492x/2112-493x HD Spredblad H + V R.Beater lug R + L Streuschaufel R + L	ST 70/90 ST 9500 ST 12000
	2112-875x/2112-876x Spredblad H + V R.Beater lug R + L Streuschaufel R + L	ST 70/90 ST 9500 ST 12000
	2231-099x/2231-100x Spredblad H + V R.Beater lug R + L Streuschaufel R + L	ST 70/90 ST 9500 ST 12000
	1214-2222 Stålskrue Steel screw Stahlschraube	ST 70/90 ST 9500 ST 12000

MTS 12000

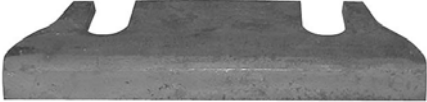
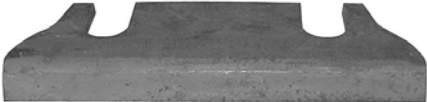
Product	-JF- Part no.	Type of machine
	<p>1364-4501</p> <hr/> <p>Kædeled Chain link Kettenglied</p>	<p>MTS 12000</p>
	<p>2247-478x/2247-479x</p> <hr/> <p>Spredeblad H + V R.Beater lug R + L Streuschaufel R + L</p>	<p>MTS 12000</p>
	<p>3247-741x</p> <hr/> <p>Transportlamel Conveyor slat Förderlamelle</p>	<p>MTS 12000</p>
	<p>2247-475a</p> <hr/> <p>Kniv Knife Messer</p>	<p>MTS 12000</p>
	<p>3247-743x</p> <hr/> <p>Kædehjul Chain link Kettenglied</p>	<p>MTS 12000</p>
	<p>2247-167x</p> <hr/> <p>Lejebøsning Bearing bush Lagerbuchse</p>	<p>MTS 12000</p>







ES 3500

Product	-JF- Part no.	Type of machine
	<p>2755-154x</p> <p>Kædehjul Chain link Kettenglied</p>	<p>ES 3500 Vognsektion Trailer section Wagensektion</p>
	<p>2755-150x</p> <p>Transportlamel Conveyor slat Förderlamelle</p>	<p>ES 3500 Vognsektion Trailer section Wagensektion</p>
	<p>3064-430x</p> <p>5 stk. 2064-096x HD 5 pcs. 2064-096x HD 5 stck. 2064-096x HD</p>	<p>ES 3500 Snitterforsats Chopping unit Schneidvorsatz</p>
	<p>2060-790x</p> <p>Kniv Tungsten Knive Wolfram Messer Wolfram</p>	<p>ES 3500 Snitterforsats Chopping unit Schneidvorsatz</p>
	<p>2064-134x</p> <p>Underlag for kniv Support for knife Unterlage für Messer</p>	<p>ES 3500 Snitterforsats Chopping unit Schneidvorsatz</p>
	<p>3064-432x</p> <p>Knivbolte/ møtrikker Knife bolts/ nuts Messerbolzen/ Mutter</p>	<p>ES 3500 Snitterforsats Chopping unit Schneidvorsatz</p>
	<p>3065-623x</p> <p>Afstryger Stripper Abstreifer</p>	<p>ES 3500 Snitterforsats Chopping unit Schneidvorsatz</p>

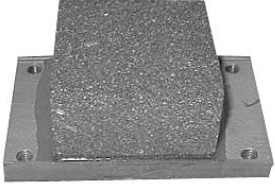
ES 3500

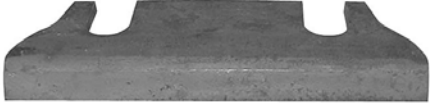
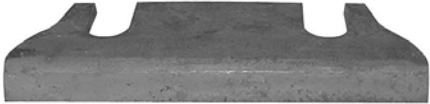
Product	-JF- Part no.	Type of machine
	<p>3062-596x</p> <p>Slibesten Grindstone Schleifstein</p>	<p>ES 3500 Snitterforsats Chopping unit Schneidvorsatz</p>
	<p>2062-266a</p> <p>Modskær Shearbar Gegenschneide</p>	<p>ES 3500 Snitterforsats Chopping unit Schneidvorsatz</p>
	<p>2065-131x</p> <p>Bøsning for pick-up Bush for pick-up Buchse für Pick-up</p>	<p>ES 3500 Snitterforsats Chopping unit Schneidvorsatz</p>
	<p>2062-392a</p> <p>Afstryger Stripper Abstreifer</p>	<p>ES 3500 Snitterforsats Chopper unit Schneidvorsatz</p>
	<p>1435-0026/1435-0027</p> <p>Pick-up fjeder Pick-up spring Pick-up Feder</p>	<p>ES 3500 Snitterforsats Chopping unit Schneidvorsatz</p>
	<p>1331-9998</p> <p>Løberulle for pick-up Roller for pick-up Laufrolle für Pick-up</p>	<p>ES 3500 Snitterforsats Chopping unit Schneidvorsatz</p>
	<p>2065-134x</p> <p>Bøsning for pick-up Bush for pick-up Buchse für Pick-up</p>	<p>ES 3500 Snitterforsats Chopping unit Schneidvorsatz</p>

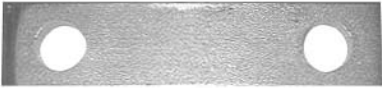





FCT Eksaktsnitter - Precision Chopper - Exakthäcksler

Product	-JF- Part no.	Type of machine
	3062-596x Slibesten Grindstone Schleifstein	FCT 1050
	2062-266a Modskær Shearbar Gegenschneide	FCT 1050/1150
	2060-790x Kniv Tungsten Knife Wolfram Messer Wolfram	FCT
	3064-430x 5 stk. 2064-096x HD 5 pcs. 2064-096x HD 5 stck. 2064-096x HD	FCT
	2062-392a Afstryger Stripper Abstreifer	FCT 1050/1150
	2064-134x Underlag for kniv Support for knife Unterlage für Messer	FCT
	1435-0026/1435-0027 Pick-up fjeder Pick-up spring Pick-up Feder	FCT

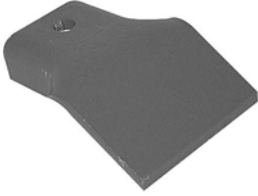





FCT Eksaktsnitter - Precision Chopper - Exakthäcksler

Product	-JF- Part no.	Type of machine
	2065-623x Afstryger Stripper Abstreifer	FCT
	2065-962x Modskær Shear bar Gegenschneide	FCT 1100 MK 2
	2065-333x Afstryger Stripper Abstreifer	FCT 1100 MK 2
	2065-131x Bøsning for pick-up Bush for pick-up Buchse für Pick-up	FCT
	1331-9998 Løberulle for pick-up Roller for pick-up Laufrolle für Pick-up	FCT
	3064-432x knivbolte/ møtrikker Knife bolts/ nuts Messerbolzen/ Mutter	FCT
	2065-634x Bøsning for pick-up Bush for pick-up Buchse für Pick-up	FCT





FH Foderhøster - Forage Harvester - Schlegelfeldhäcksler

Product	-JF- Part no.	Type of machine
	2129-234x Kniv Knife Messer	FH
	1361-9105 Kilerem V-belt Keilriemen	FH
	1391-0879 EL-Motor Electric motor Elektromotor	FH
	1391-0854 EL-Motor Electric motor Elektromotor	FH
	2129-235x Øje for kniv Eye for knife Öse für Messer	FH
	1219-0708 Kniv bolt Knife bolt Messer bolzen	FH
	1220-4323 Møtrik for knivbolt Nyloc nut for Knife bolt Mutter für Messerbolzen	FH



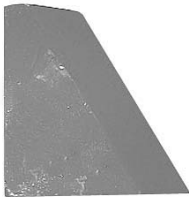
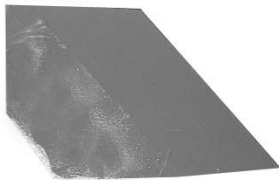

PA Feeder

Product	-JF- Part no.	Type of machine
	1363-0421 Kæde 3/4" Chain 3/4" Kette 3/4"	FEEDER PA 10/12/14/15
	1363-0422 Kæde 1 1/4" Chain 1 1/4" Kette 1 1/4"	FEEDER PA 10/12/14/15
	1363-0427 Kæde 1 3/4" Chain 1 3/4" Kette 1 3/4"	FEEDER PA 10/12
	1363-9059 Samleled 3/4" Joint link 3/4" Zwischenglied 3/4"	FEEDER PA 10/12/14/15
	1363-9060 Samleled 1 1/4" Joint link 1 1/4" Zwischenglied 1 1/4"	FEEDER PA 12/14/15
	1363-9052 Samleled 1 3/4" Joint link 1 3/4" Zwischenglied 1 3/4"	FEEDER PA 10/12
	1363-9061 Samleled 1 3/4" Joint link 1 3/4" Zwischenglied 1 3/4"	FEEDER PA 14/15







PA Feeder

Product	-JF- Part no.	Type of machine
	1363-0423 Kæde 1 3/4" Chain 1 3/4" Kette 1 3/4"	FEEDER PA 14/15
	1363-0424 Kæde 1 " Chain 1 " Kette 1 "	FEEDER PA 19
	1363-0426 Kæde 2 " Chain 2 " Kette 2 "	FEEDER PA 19
	1363-0425 Kæde 1 1/2" Chain 1 1/2" Kette 1 1/2"	FEEDER PA 19
	3701-286x Gummiskraber Rubber scraper Gummischubstahl	FEEDER PA 10/12/14/15/19
	2701-166x Kniv til svøb Knife for vessel Messer für Gefäss	FEEDER PA 10/12/14/15/19
	2701-284x Lang Kniv til svøb Long knife for vessel Lange Messer für Gefäss	FEEDER PA 10/12/14/15/19







VM Feeder

Product	-JF- Part no.	Type of machine
	<p>1380-0034</p> <hr/> <p>Kniv Knife Messer</p>	<p>VM</p>
	<p>2710-068x</p> <hr/> <p>Plade til Kniv Plate for knife Platte für Messer</p>	<p>VM</p>
	<p>1214-322/1219-0270</p> <hr/> <p>Bolt + møtrik for kniv Screw + nut for knife Schr.+ Mut. f. Messer</p>	<p>VM</p>
	<p>1214-3230</p> <hr/> <p>Sikringsbolt Shear bolt Abscherschrauben</p>	<p>VM 19/22/27</p>
	<p>1214-2226</p> <hr/> <p>Sikringsbolt Shear bolt Abscherschrauben</p>	<p>VM 10/12/14</p>







Handelsvarer - Commodities - Handelswaren

Product	-JF- Part no.	Type of machine
	<p>1364-2201</p> <hr/> <p>Kædeled nr. 57 Chain link no 57 Kettenglied Nr. 57</p>	
	<p>1364-4401</p> <hr/> <p>Kædeled nr. 72,5 Chain link no 72,5 Kettenglied Nr. 72,5</p>	
	<p>1364-4501</p> <hr/> <p>Kædeled nr. 74 Chain link no 74 Kettenglied Nr. 74</p>	
	<p>1364-3301</p> <hr/> <p>Kædeled nr. 78 Chain link no 78 Kettenglied Nr. 78</p>	
	<p>1364-3302</p> <hr/> <p>Kædeled nr. 103C Chain link no 103C Kettenglied Nr. 103C</p>	
	<p>ST0518280</p> <hr/> <p>Lige tand 800 mm Tine 800 mm Zahn 800 mm</p>	<p>Frontlæsser Front loader Frontlader</p>
	<p>ST1408090</p> <hr/> <p>Læssertand 980 mm Tine 980 mm Zahn 980 mm</p>	<p>Frontlæsser Front loader Frontlader</p>

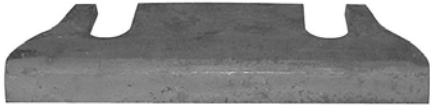

Handelsvarer - Commodities - Handelswaren

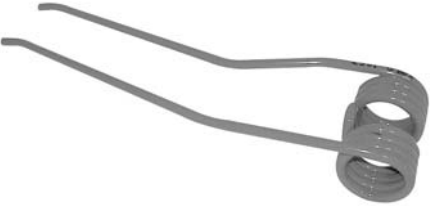
Product	-JF- Part no.	Type of machine
	ST1330130 Læssertand 1250 mm Tine 1250 mm Zahn 1250 mm	Frontlæsser Front loader Frontlader
	ST0454430 Tand f. siloklo 28x800 Tine for silage Zahn für Silage	Frontlæsser Front loader Frontlader
	ST0476250 Tand forsat 815 mm Tine staggered 815mm Zahn versetz 815 mm	Frontlæsser Front loader Frontlader
	ST0540637 Lige tand 600 mm Tine 600 mm Zahn 600 mm	Frontlæsser Front loader Frontlader
	1363-8011 Kæde 3/4" 60HE-1 Chain 3/4" 60HE-1 Kette 3/4" 60HE-1	Længde 5 m. Lenght 5 m. Länge 5 M.
	1363-9054 1/2 led 3/4" 1/2 link 3/4" 1/2 Glied 3/4"	For 1363-8011 For 1363-8011 Für 1363-8011
	1363-9053 Samleled 3/4" Joint link 3/4" Zwischenglied 3/4"	For 1363-8011 For 1363-8011 Für 1363-8011

Salgspakker - Sales Parcels - Verkaufspakete

Product	-JF- Part no.	Type of machine
	3064-430x 5 stk.2064-096x HD 5 pcs.2064-096x HD 5 stck.2064-096x HD	FCT ES
	3064-431x 5 stk.2064-103a 5 pcs.2064-103a 5 stck.2064-103a	FC FCT
	3064-432x 10/ 1214-5231 +1220-6125 10/1214-5231 +1220-6125 10/1214-5231 +1220-6125	FCT ES
	3081-600x 10/ 1219-0807 + 1220-4323 10/1219-0807 + 1220-4323 10/1219-0807+ 1220-4323	SB
	3081-601x 10/1219-0809 + 1220-4323 10/1219-0809 + 1220-4323 10/1219-0809 + 1220-4323	GX GMS
	3195-600x 3/ 1433-0200 + 2/1433-0201 3/ 1433-0200 + 2/1433-0201 3/ 1433-0200 + 2/1433-0201	CR 320 CR 400
	3229-781x 25 stk. 2226-070x+ 2226-071x 25 pcs. 2226-070x+ 2226-071x 25 Stck.2226-070x+ 2226-071x	CM CMT GMS

Salgspakker - Sales Parcels - Verkaufspakete

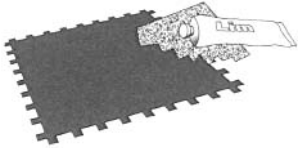
Product	-JF- Part no.	Type of machine
	<p>3229-782x</p> <hr/> <p>20 stk. 2225-518x+ 2225-519x 20 pcs. 2225-518x+ 2225-519x 20 Stck.2225-518x+ 2225-519x</p>	<p>GX</p>
	<p>3113-304x</p> <hr/> <p>Reparationssæt for lakskader Repair set for paint damage Reparatursatz für Lackschäden</p>	<p>Alle -JF- maskiner All -JF- machines Alle -JF- Maschinen</p>
	<p>3755-754x</p> <hr/> <p>Reparationssæt for net Repair set for net Reparatursatz für net</p>	<p>AV ST ES</p>

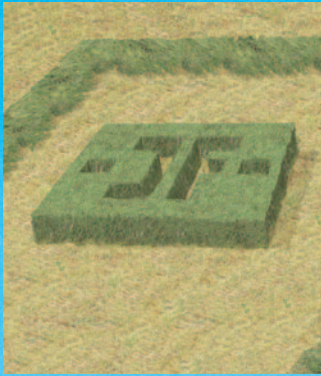

JF er en af verdens førende producenter af slåmaskiner. Kundelisten fordeler sig på store og små brug samt maskinstationer i over 90 lande. Positionen er skabt gennem 50 års målrettet og intensiv produktudvikling kombineret med en bevidst specialiseringsstrategi. Produktudviklingen er 100% behovsorienteret. Den foregår

i tæt, løbende dialog med kunder, forhandlere, landbrugsteknikere og landbrugsforskere i hele verden. Kvalitetsmæssigt er JF-maskinerne også i verdenseliten. Kvalitetskontrollen er totalomfattende. Den starter, når råvarerne kommer ind og slutter med en marktest af den færdige maskine under de mest ekstreme forhold.

Vægtet du optimal driftsvenlighed, driftssikkerhed, højt udbytte og lang levetid højt, så er JF et sikkert valg. Vi er specialisten, du kan regne med år efter år.

JF is among the leading producers of mowers. The customers are both small and big farms and contractors in more than 90 countries. JF has worked itself up to this position through a 40 year period of goal-oriented and intensive product development combined with a calculated specialisation strategy. The product development

is 100 per cent demand-oriented. It takes place in close, continuous dialogues with customers, dealers, agricultural technicians and research workers all over the world. Regarding the quality of JF machines they are among the world's élite. The quality control is extensive and starts when the raw material comes

in and finishes with a field test of the finished machine under most extreme conditions. If you appreciate optimum and friendly service, reliability, high yield and long life, JF is the best choice. We are the specialists you can count on year after year.

JF ist einer der führenden Hersteller von Mähwerken. Die Kunden verteilen sich auf Groß- und Kleinbetriebe sowie Lohnunternehmer in mehr als 90 Ländern. Diese Marktposition ist durch eine 50-jährige gezielte und intensive Produktentwicklung, kombiniert mit einer bewußten Spezialisierungsstrategie erreicht worden.

Die Produktentwicklung ist 100% bedarfsgerecht. Sie erfolgt laufend in engem Dialog mit den Kunden, Händlern, Agrartechnikern und -Forschern in der ganzen Welt. Die Qualität der JF-Maschinen gehört weltweit zur Elite. Umfassend ist die Qualitätskontrolle. Sie beginnt bei den eintreffenden Rohwaren und

endet mit einem Test der fertigen Maschine auf dem Feld unter ganz extremen Bedingungen. Legen Sie Wert auf freundliche Bedienung, Betriebssicherheit, hohe Leistung und lange Lebensdauer, dann ist JF eine sichere Wahl. Wir sind der Spezialist mit dem Sie Jahr für Jahr rechnen können.

